

A	OTWIERANIE
B	ZAMYKANIE

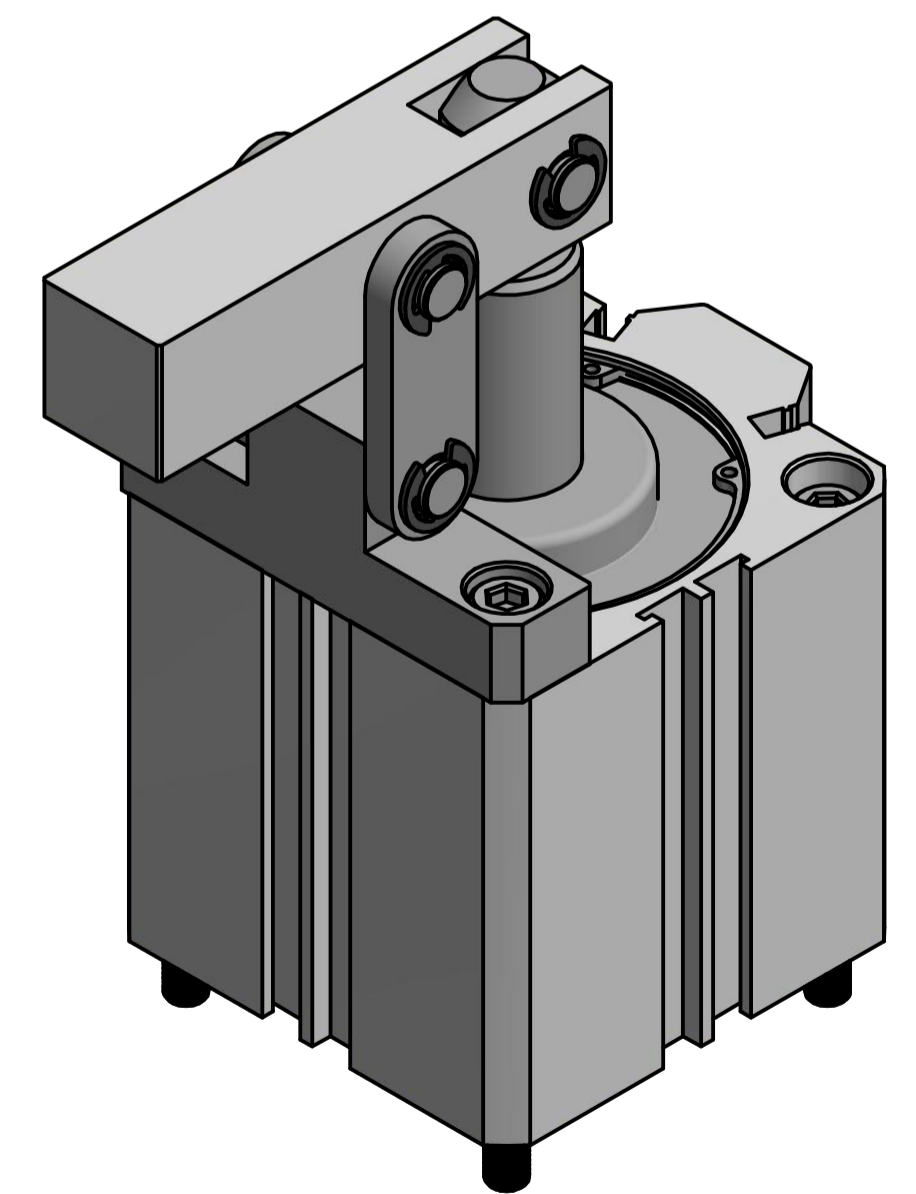
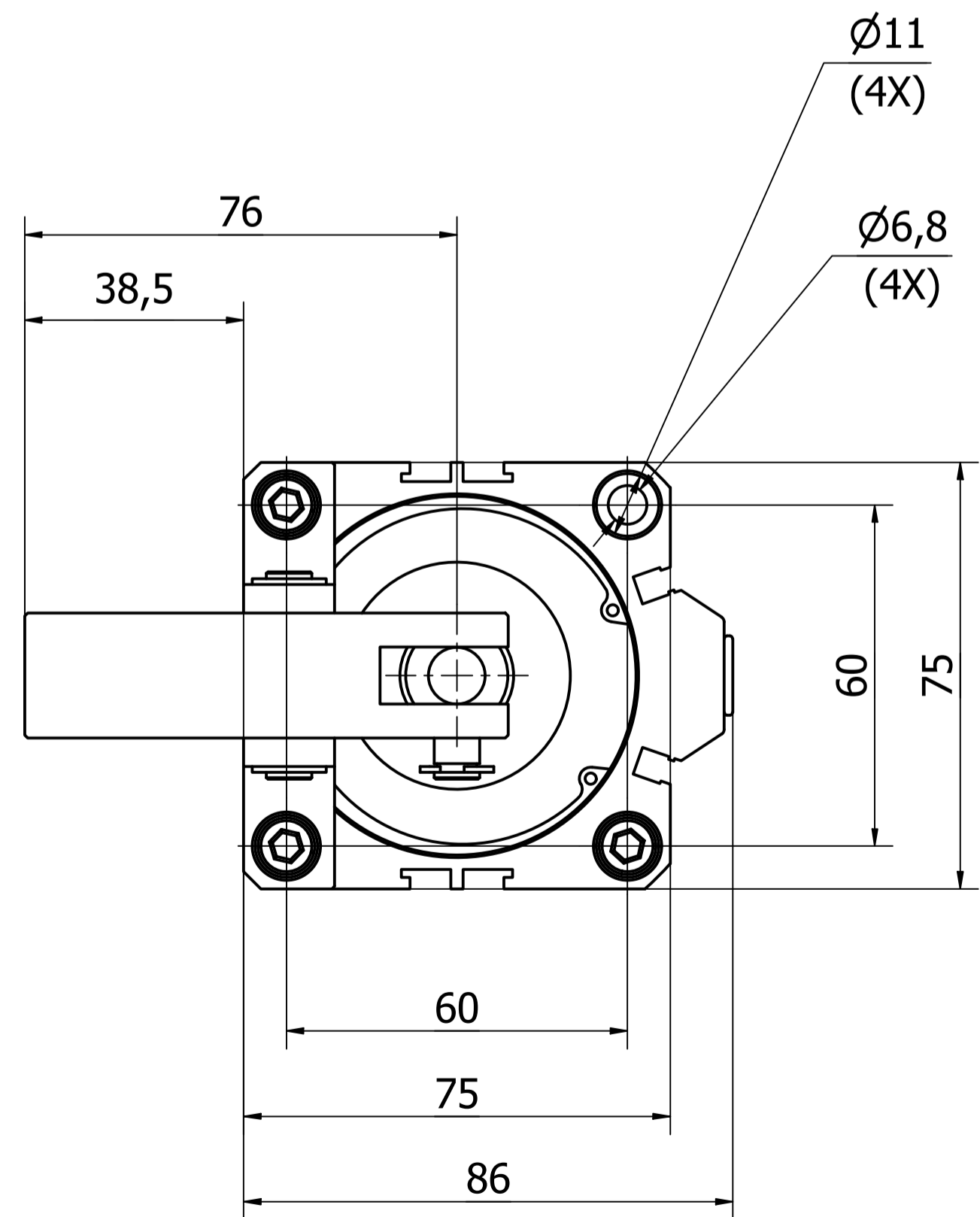

Format	A1	Typ docisku	DOCISK PNEUMATYCZNY
Skala	1:1	Numer docisku	CALC-63