

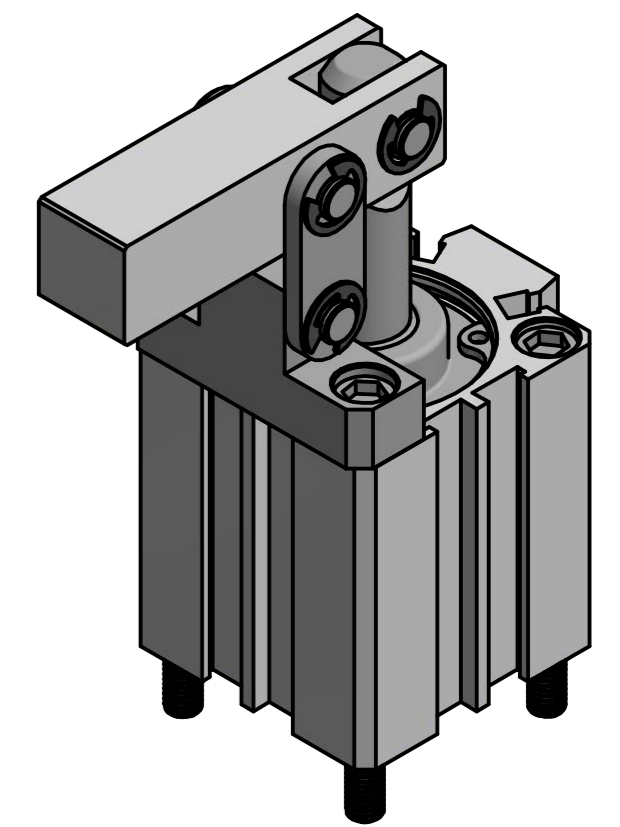

A	OTWIERANIE
B	ZAMYKANIE

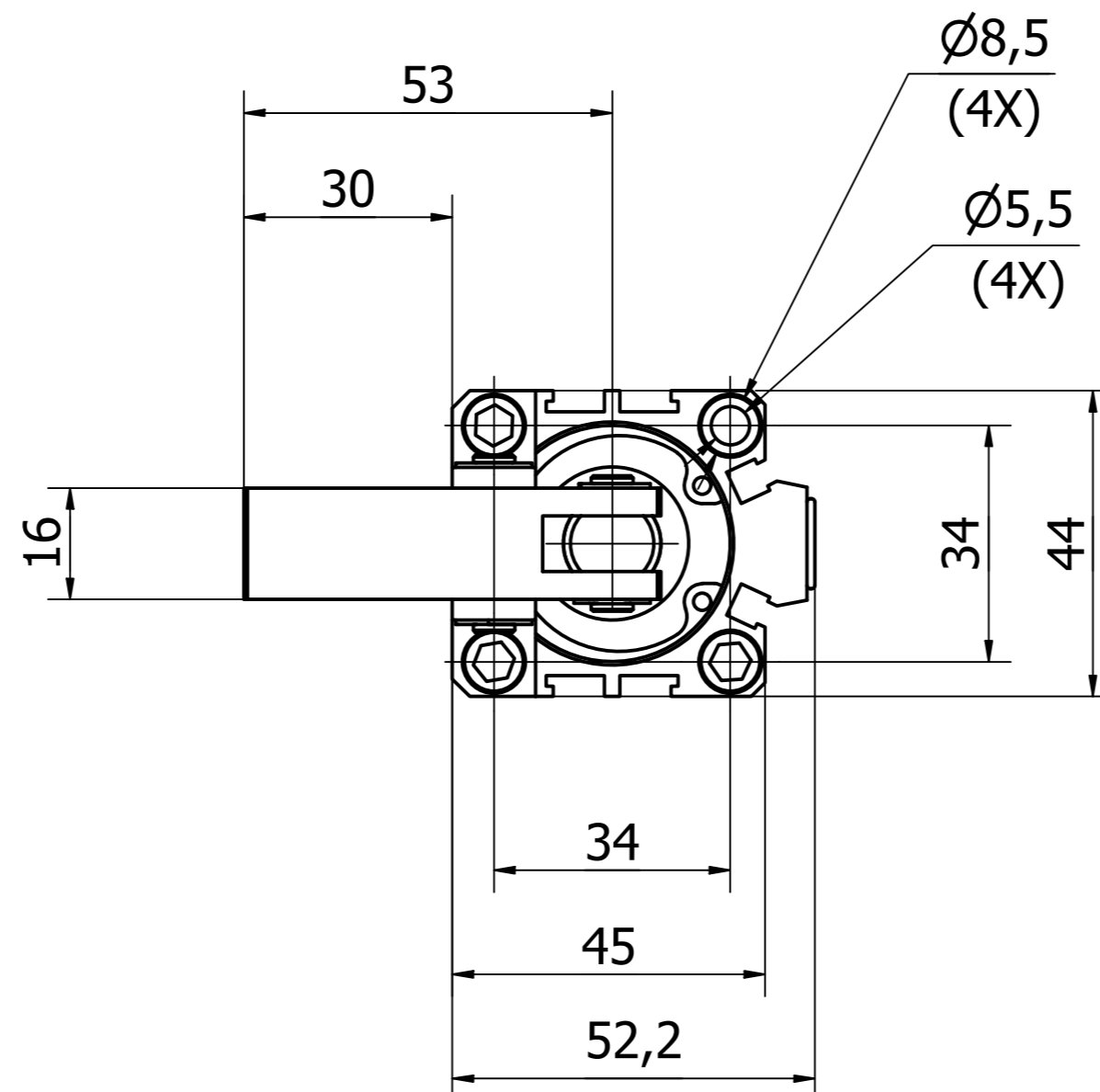

Format	A2		Typ docisku	DOCISK PNEUMATYCZNY
Skala	1:1		Numer docisku	CALC-32